

Parts Diagram

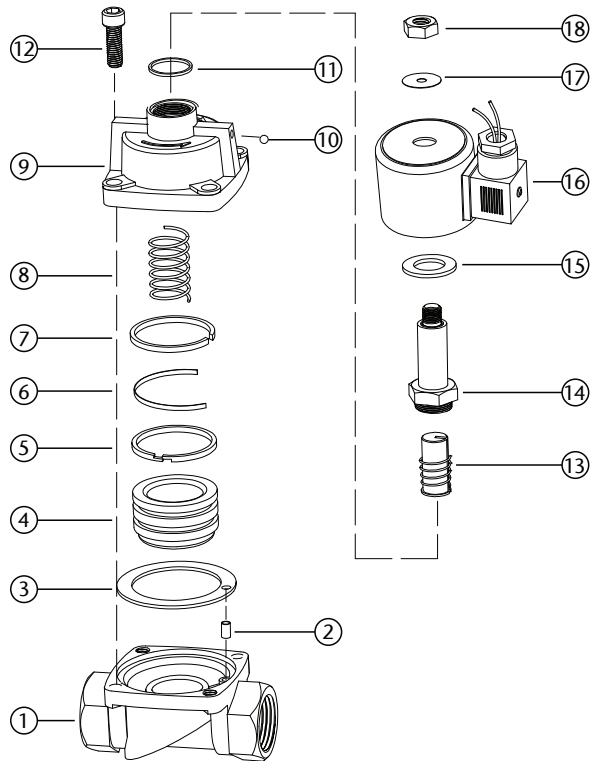

N.	Component	Material
1	Valve Body	Brass/Stainless Steel 316
2	Pin	Stainless Steel 304
3	Seal	PTFE
4	Piston unit	Stainless Steel 316
5	Piston Ring 1	PTFE
6	Elastic Ring	Spring Steel
7	Piston Ring 1	PTFE
8	Piston Spring	Stainless Steel 304
9	Valve Cover	Brass/Stainless Steel 316
10	Bolt	Brass/Stainless Steel 304
11	Plunger Tube Seal	PTFE
12	Bolt	Stainless Steel 302
13	Pilot Unit	Stainless Steel 1J117
14	Plunger Tube Unit	Stainless Steel 304 +1J117
15	Baseplate	Plated Steel
16	Coil	Enamelled Wire
17	Washer	Plated Steel
18	Lock Nut	Stainless Steel 302

Available in 240VAC, 110VAC
12VDC, 24VDC, 24VAC

Main Dimensions

See Table Opposite

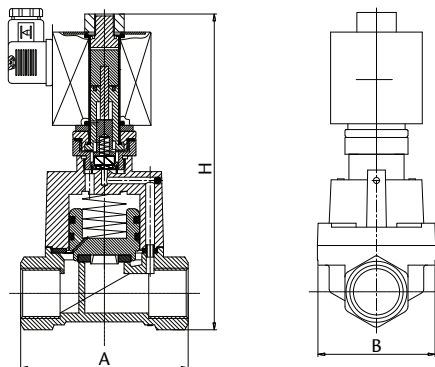

2/2 Solenoid Valve Normally Closed

Valve Specification

Port Size (G)	Orifice	CV Value	Pressure Difference (Bar)								Max. Temp. (°C)	VA	W	Diaphragm	Main Dimension
			Min.	Max. Working Pressure				Steam AC/DC	AxBxH						
				Air / Gas		Water / Hot Liquid				Light Oil ≤20CST					
AC	DC	AC	DC	AC	DC	AC	DC	AC/DC							
1/8"	2.5	0.23	0	8	8	8	8	6	6	8	175	22	13	PTFE	48x25x85.5
	2.5	0.23	0	13	13	13	13	7	7	10	110	22	13	VITON	48x25x85.5
	4.5	0.6	0	7	4	7	4	4	4	7	165	22	13	PTFE	58x25x85.5
	4.5	0.6	0	7	4	7	4	4	4	7	110	22	13	VITON	58x25x85.5
1/4"	2.5	0.23	0	7	4	7	4	4	4	8	175	22	13	PTFE	48x25x85.5
	2.5	0.23	0	13	13	13	7	7	7	10	110	22	13	VITON	48x25x85.5
	4.5	0.6	0	7	4	7	4	4	4	7	165	22	13	PTFE	58x25x85.5
	4.5	0.6	0	7	4	7	4	4	4	7	110	22	13	VITON	58x25x85.5
3/8"	15	4.5	0.5	25	20	25	20	20	20	8	175	30	25	PTFE	75x52x129
1/2"	15	4.5	0.5	25	20	25	20	20	20	8	175	30	25	PTFE	75x52x129
3/4"	20	9	0.5	25	20	25	20	20	20	8	175	30	25	PTFE	85x60x141
1"	25	13	0.5	25	20	25	20	20	20	8	175	30	25	PTFE	100x70x148
1.1/4"	35	26	0.5	25	20	25	20	20	20	8	175	30	25	PTFE	120x90x168
1.1/2"	35	26	0.5	25	20	25	20	20	20	8	175	30	25	PTFE	120x90x168
2"	50	48	0.5	25	20	25	20	20	20	8	175	30	25	PTFE	150x110x190
1" Flange	25	13	0.5	25	20	25	20	20	20	8	175	30	25	PTFE	134x110x185
1.1/4" Flange	35	26	0.5	25	20	25	20	20	20	8	175	30	25	PTFE	160x135x200
1.1/2" Flange	35	26	0.5	25	20	25	20	20	20	8	175	30	25	PTFE	160x145x205
2" Flange	50	45	0.5	25	20	25	20	20	20	8	175	30	25	PTFE	200x155x250

Please refer to our price list for stocked items

Dimensions in mm

This data sheet is designed as a guide and should not be regarded as wholly accurate in every detail. We reserve the right to amend the specification of any product without notice.